

## CPDH5V0U (RoHS Device)

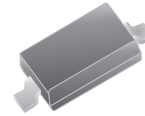

### Features

- Uni-directional ESD protection.
- (16kV) IEC 61000-4-2 rating.
- Surface mount package.
- High component density.

### Mechanical data

- Case: SOD-523 standard package ,  
molded plastic.
- Terminals: Gold plated, solderable per  
MIL-STD-750, method 2026.
- Mounting position: Any
- Weight: 0.0012 gram(approx.).

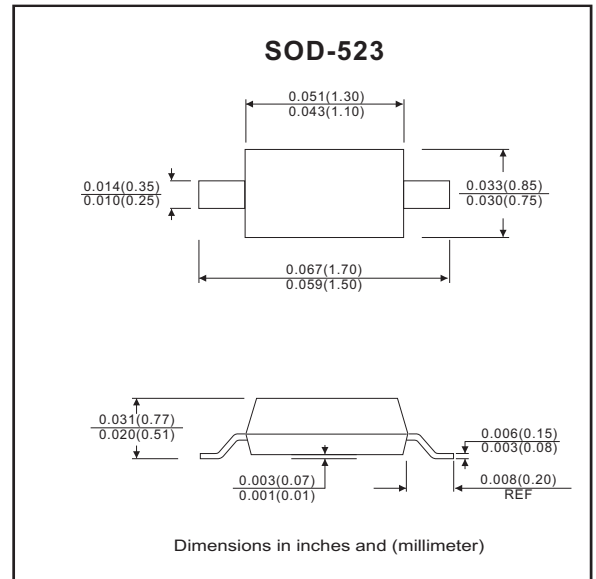

### Circuit Diagram



### Maximum Rating AND Electrical Characteristics (at TA=25 °C unless otherwise noted)

Parameter	Conditions	Symbol	Min	Typ	Max	Unit
Forward voltage	I <sub>F</sub> = 10mA	V <sub>F</sub>		0.8		V
Diode breakdown voltage	I <sub>R</sub> = 1mA	V <sub>BD</sub>	6			V
Leakage current	V <sub>R</sub> = 5V	I <sub>L</sub>		0.3	2.0	uA
Junction capacitance	V <sub>R</sub> = 0V, f = 1MHz	C <sub>T</sub>		90	120	pF
ESD capability	IEC 61000-4-2(air) IEC 61000-4-2(contact)	ESD			20 15	kV
Clamping voltage	I <sub>PP</sub> = 5A, T <sub>P</sub> =8/20us I <sub>PP</sub> = 16A, T <sub>P</sub> =8/20us	V <sub>C</sub>			9.8 12.5	V
Peak pulse power		P <sub>PP</sub>			200	W
Operation temperature		T <sub>J</sub>			125	°C
Storage temperature		T <sub>STG</sub>	-55		150	°C

## RATING AND CHARACTERISTIC CURVES (CPDH5V0U)

Fig. 1 - 8/20us Peak pulse current wave form acc. IEC 61000-4-5

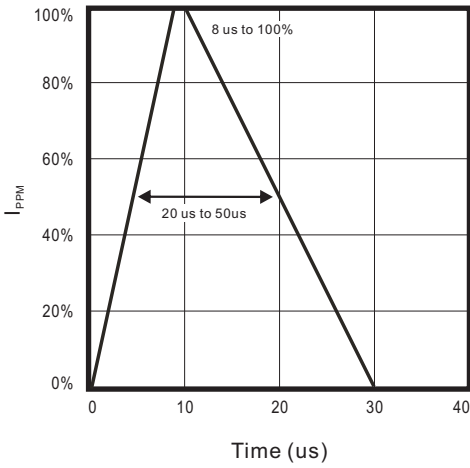

Fig. 2 - Power rating derating curve

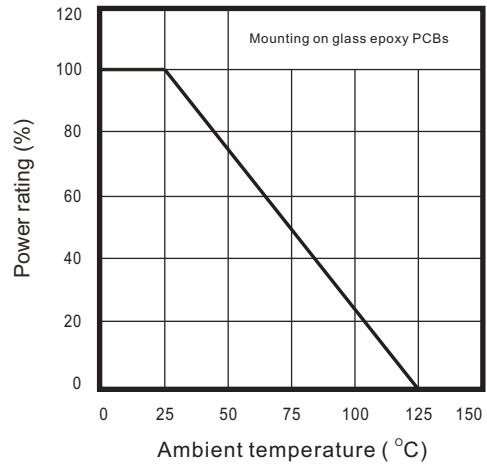

Fig. 3 - Clamping voltage vs. peak pulse current

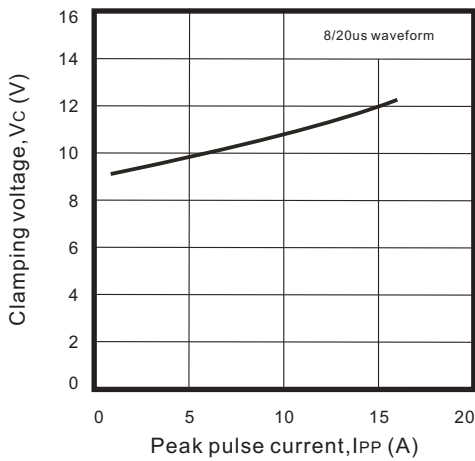

Fig. 4 - Forward voltage vs. forward current

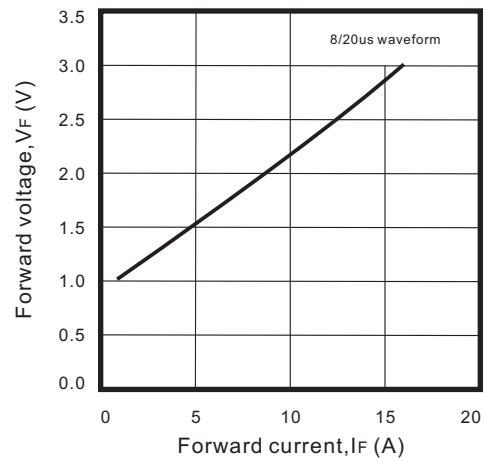
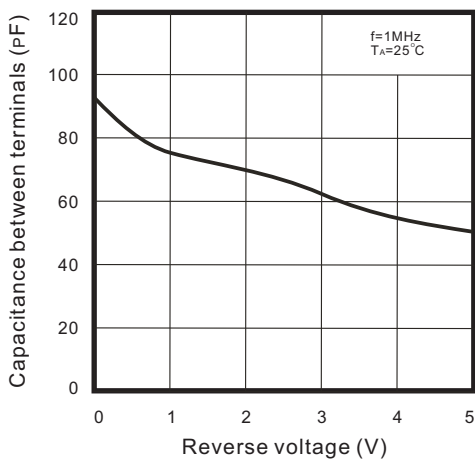
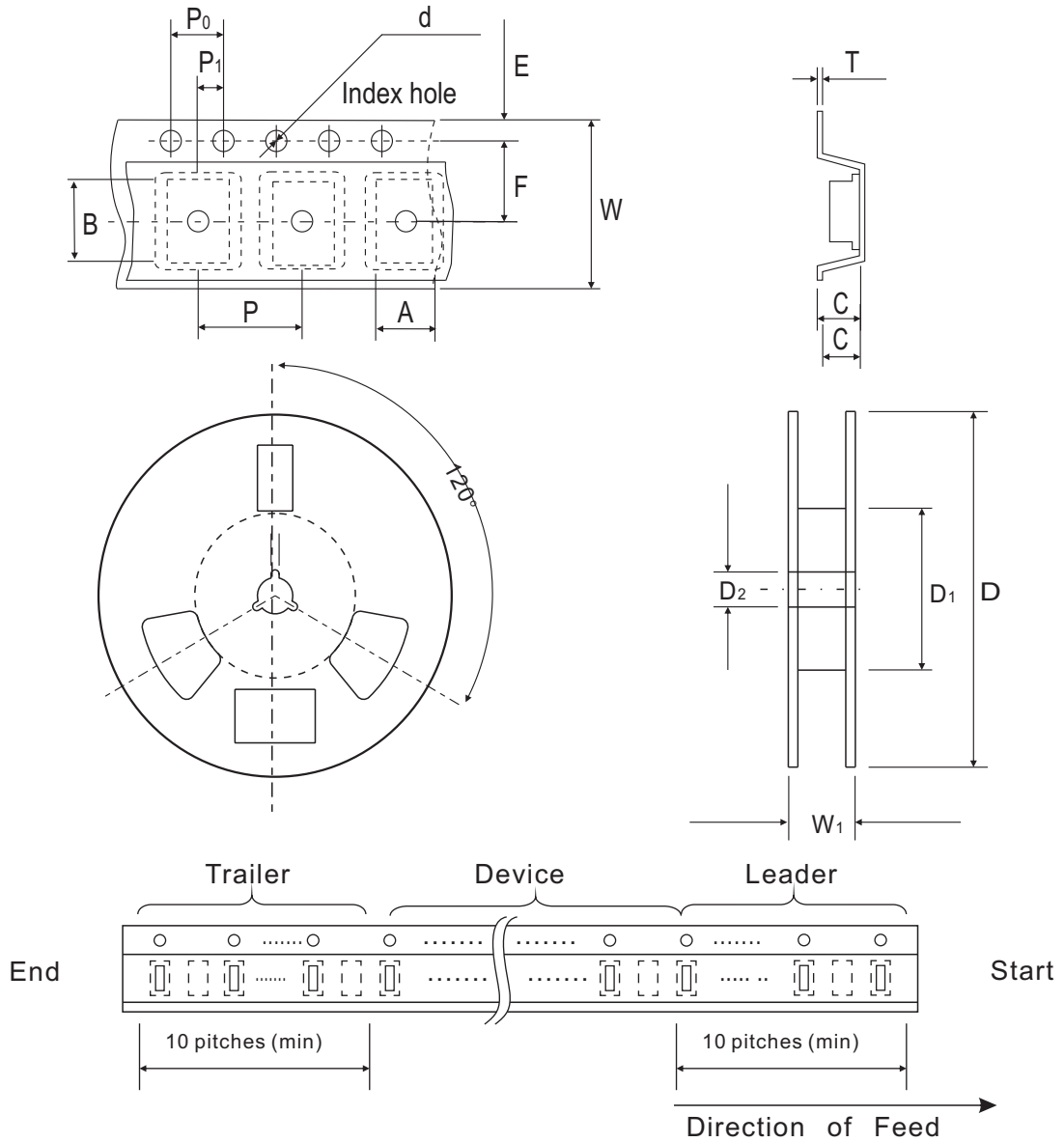

Fig. 5 - Capacitance between terminals characteristics



## Reel Taping Specification



SOD-523	SYMBOL	A	B	C	d	D	D <sub>1</sub>	D <sub>2</sub>
	(mm)	0.96 ± 0.05	1.94 ± 0.05	0.73 ± 0.05	1.50 ± 0.10	178 ± 1	54.4 ± 0.4	1.30 ± 0.05
	(inch)	0.038 ± 0.002	0.076 ± 0.002	0.029 ± 0.002	0.059 ± 0.004	7.008 ± 0.04	2.142 ± 0.016	0.512 ± 0.002

SOD-523	SYMBOL	E	F	P	P <sub>0</sub>	P <sub>1</sub>	T	W	W <sub>1</sub>
	(mm)	1.75 ± 0.10	3.50 ± 0.05	2.00 ± 0.05	4.00 ± 0.10	2.00 ± 0.05	0.18 ± 0.02	8.00 ± 0.40	12.3 ± 0.20
	(inch)	0.069 ± 0.004	0.138 ± 0.002	0.079 ± 0.002	0.157 ± 0.004	0.079 ± 0.002	0.007 ± 0.001	0.315 ± 0.016	0.484 ± 0.008

## Marking Code

Part Number	Marking Code
CPDH5V0U	E5



## Suggested PAD Layout

SIZE	SOD-523	
	(mm)	(inch)
A	1.40	0.055
B	0.60	0.024
C	0.70	0.028
D	2.00	0.079
E	0.80	0.031

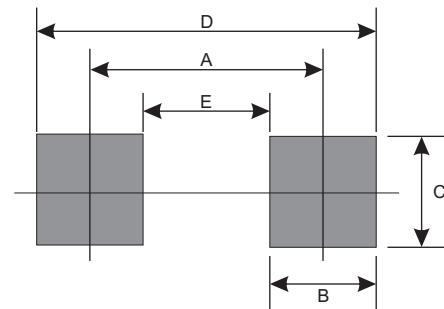

## Standard Package

Case Type	Qty per Reel	Reel Size
	(Pcs)	(inch)
SOD-523	3000	7